



safety in its most beautiful form

Hard Top Box

though smart handling the Hard Top Box

the advanced sterile container from Innovations Medical

unbeatable its design effortless the handling
safety and quality in sterilization your benefit

a sustainable, responsible investment that retains its value.

independent tests confirm the functional, safety and quality advantages of the Hard Top Box.
in the drying cycle, the aluminium alloy is superior to any plastic solution.

the sterile container from Innovations Medical surpasses all relevant standards and meets the highest requirements of the health care market.



perfection in detail

our quality standards are reflected in every detail of the Hard Top Box - from the design to the clearly labeling of the contents and the protective mechanism to ensure safety.

economically sustainable investment that retains its value

- different sizes for individual needs
- extremely stable lids and trays
- permanently maintenance - and wear-free
- no consumables (pasteurizing loop) necessary
- lid seals are securely held in a mold groove, easy and quick replacement without glue.

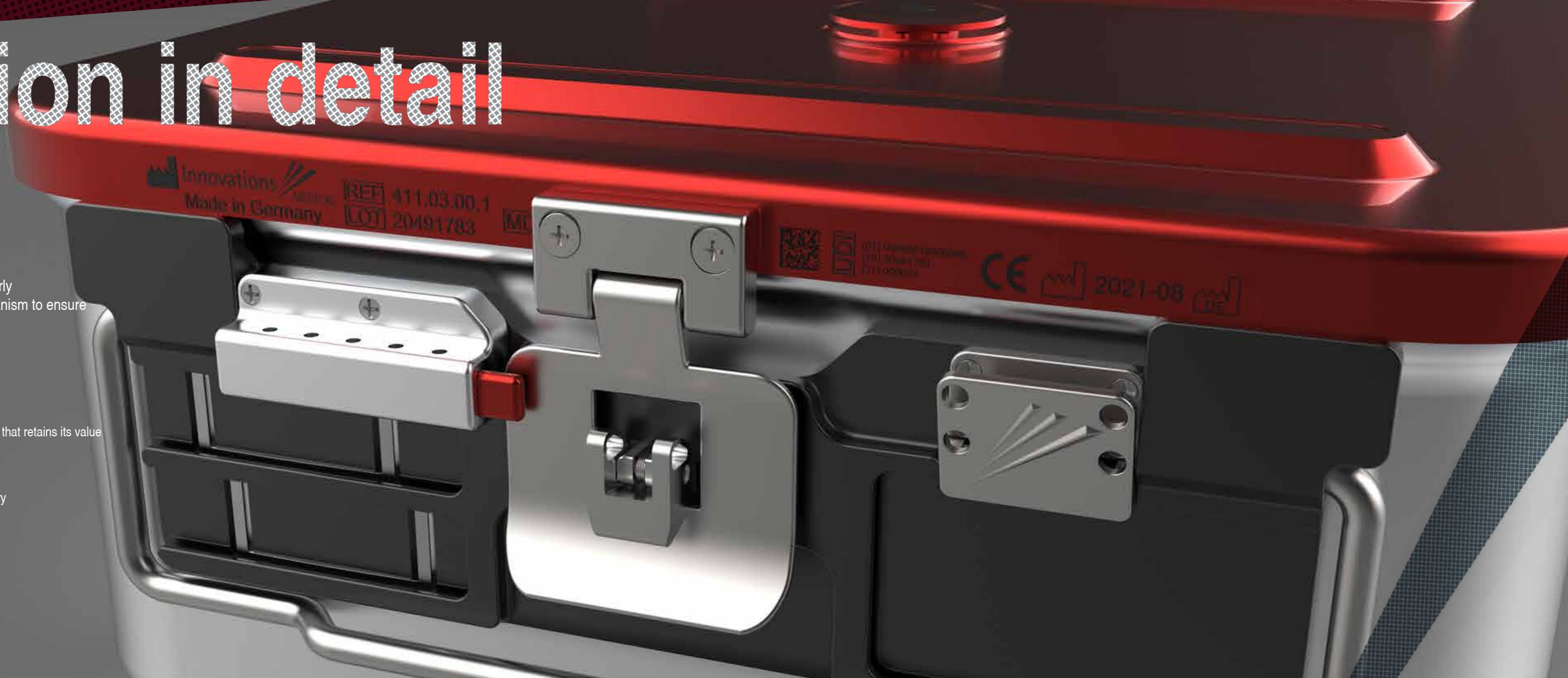

complete security the lid

the first of its kind !
precisely milled from a solid block of aluminium.
a high degree of shape and stability - created for the hard everyday life.

ergonomically simple handling | precise stacking | fast, safe use | smooth contours with flowing transition

reduced to a few attachments | the testing efforts | the drying time in the sterilizer | the effort required to change the seal | the maintenance costs



the tub



containertub

- with heavy-duty carrying handle
- positive connection of the fittings with the tub without rivet or screw connection (innovative TOX-clinch connections make leak testing of the tray unnecessary)
- with support when stacking the sterile containers
- the interior offers sufficient space for all common basket sizes
- the thickness of the tub material is optimally designed for drying and handling
- no adhesion forces due too large sealing surfaces between lid and tub

identification fittings

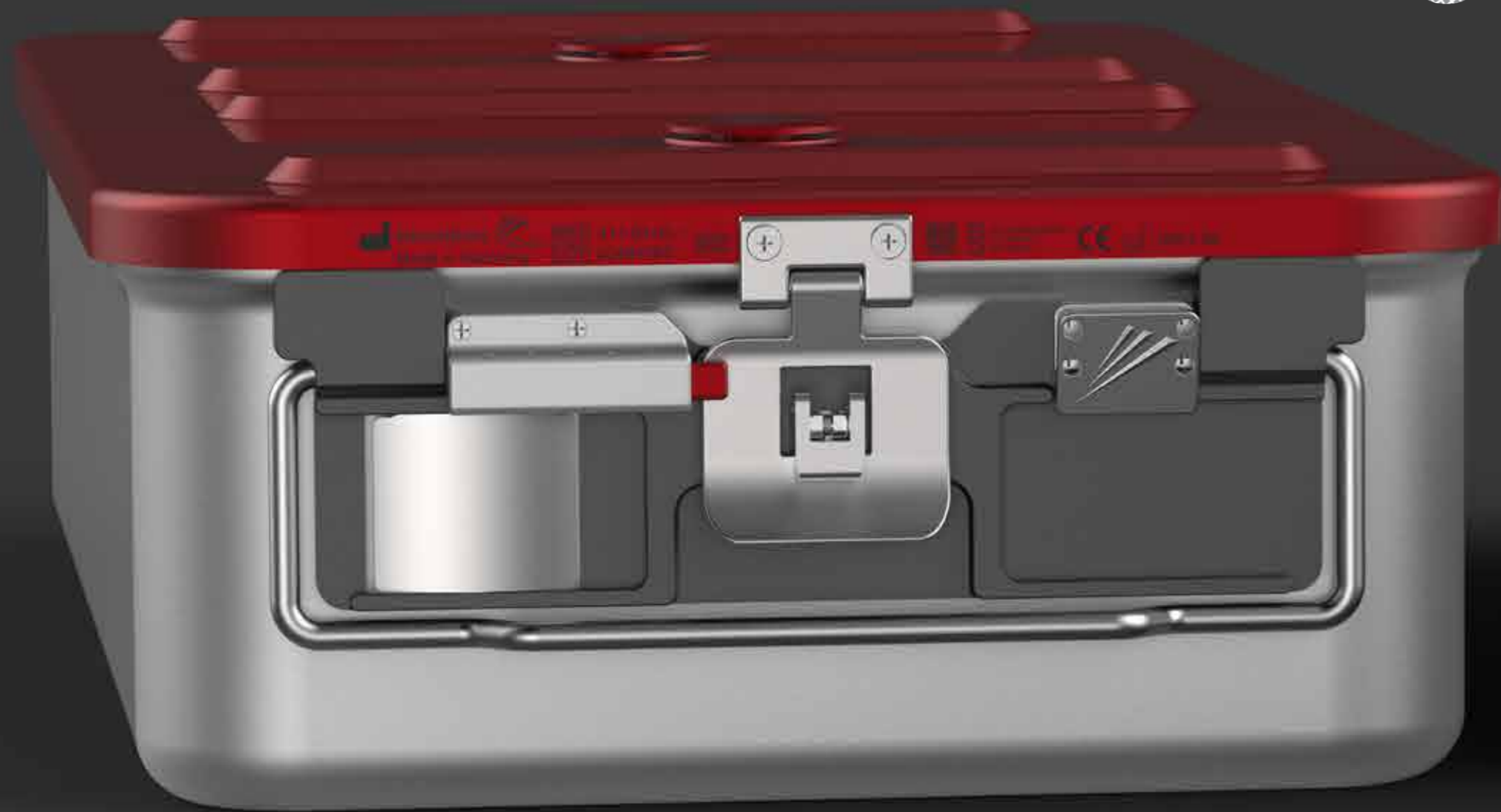

multifaceted double-sided freely selectable fittings | unique solution | secure hold for label and log label | on request with additional clip, for attaching additional information



individually the container that adapts to your requirements for size, identification and filter system

EasyStop

ingeniously simple, simply ingenious



the ring-rib labyrinth stops microbes, germs and particles in the aeration flow.
the sterile material remains permanently protected and ensures maximum patient safety.

safety through innovation

EasyStop

the EasyStop system without consumption filter.

with the EasyStop system Innovations Medical is responding to the growing demands for sterility, environmental protection and convenience in handling.

EasyStop stops microorganisms even more effectively than conventional disposable filters and can be used as often as required.

the filtration efficiency achieved is 99,997%.

one handle is all that is needed to open or close the filter: press in the filter cover, turn- and you're done.

filtersystems

paper disposable filter
PTFE permanentfilter

tightness

in addition to the filter cover with integrated sealing rings, there are, as an absolutely unique feature, additional sealing rings on the inside of the container cover. This allows our sterilization containers to achieve a much higher level of tightness.

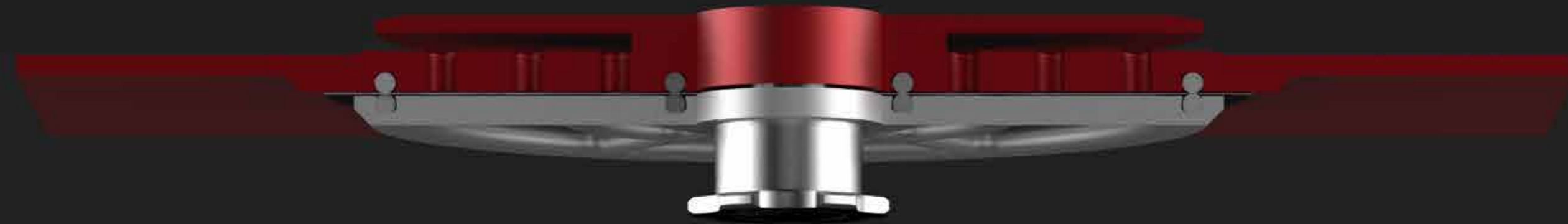

proven and optimized

Innovations Medical has further developed the successful system with exchangeable filters.

The proven filter media are used as a germ barrier.

A logical safety mechanism locks the filter cover. This can be unlocked, locked and latched by a simple turning, pushing movement.

The locking status can be detected at any time, making the system even safer.

single-use filter

single-use filter

- suitable for sterile containers with filter holder for disposable paper filter
- the disposable paper filter is changed during each sterilization cycle
- the classic filter technology



permanentfilter



permanentfilter

- suitable for sterile containers with filter holder for permanent filter
- the permanent filter remains in the filter holder for the entire cycle time
- no need to change filters during reprocessing until cycle time is reached (1200 cycles)
- extremely durable, long-lasting and chemical-resistant



MD



UDF

filterdisplay visual recognition of the inserted filter discs

sealed classically with seal or automatically during sterilization via an optional thermolock

safely completed, standard-compliant sterilization | incorruptible control by seal | unique coding by color labels | fully visible, large identification fitting for identification and protocol label | smooth surfaces avoid the risk of injury

410.05.13.2-18.00
20571361
CE

colors

especially
the ph-resistant anodizing process

color flexible you choose from a wide range

identification signs

mark with almost unlimited possibilities | individual color, text and code

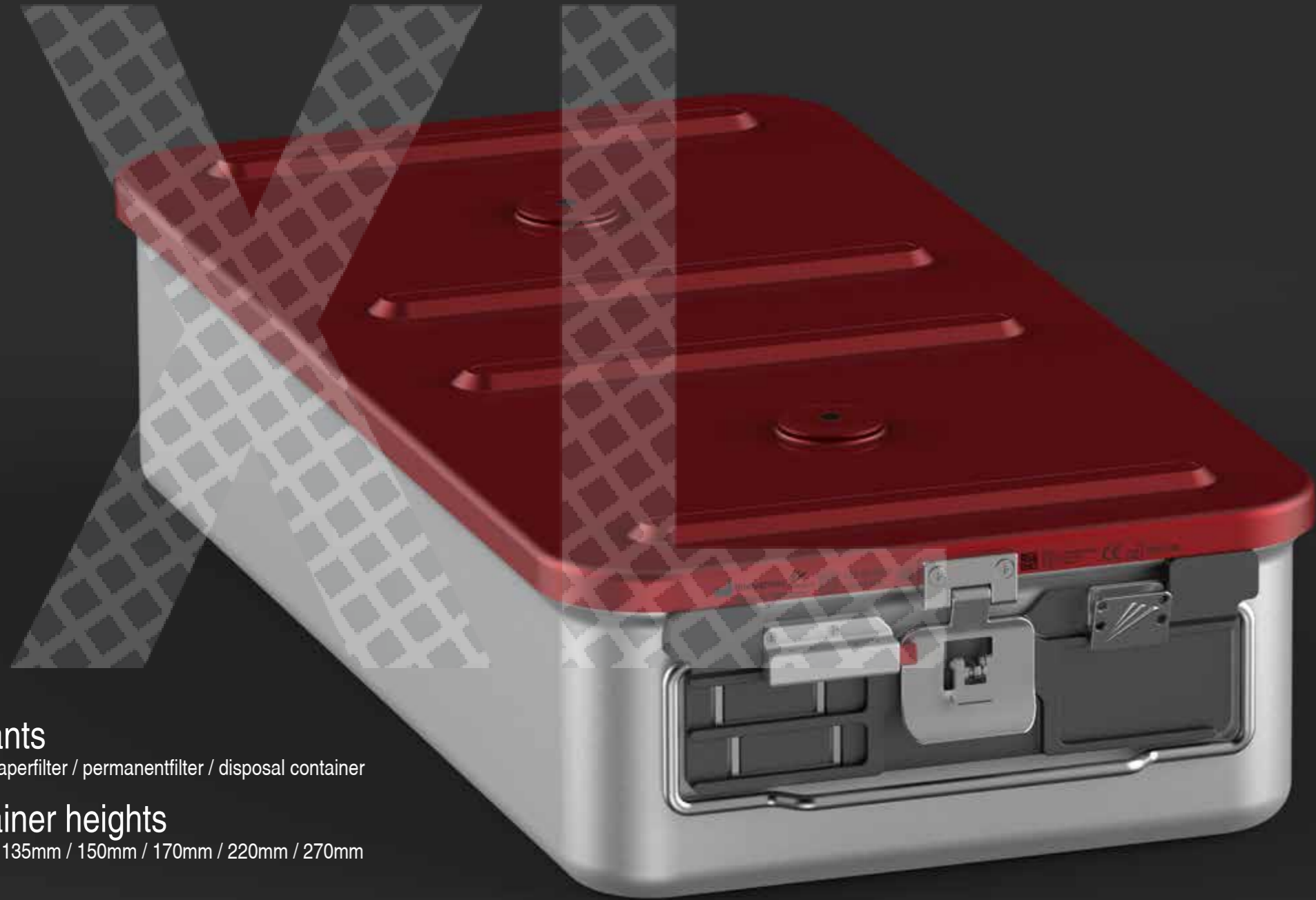

lid variants

EasyStop / paperfilter / permanentfilter / disposal container

container heights

100mm / 135mm / 150mm / 170mm / 220mm / 270mm



lid variants

EasyStop / paperfilter / permanentfilter / disposal container

container heights

100mm / 135mm / 150mm

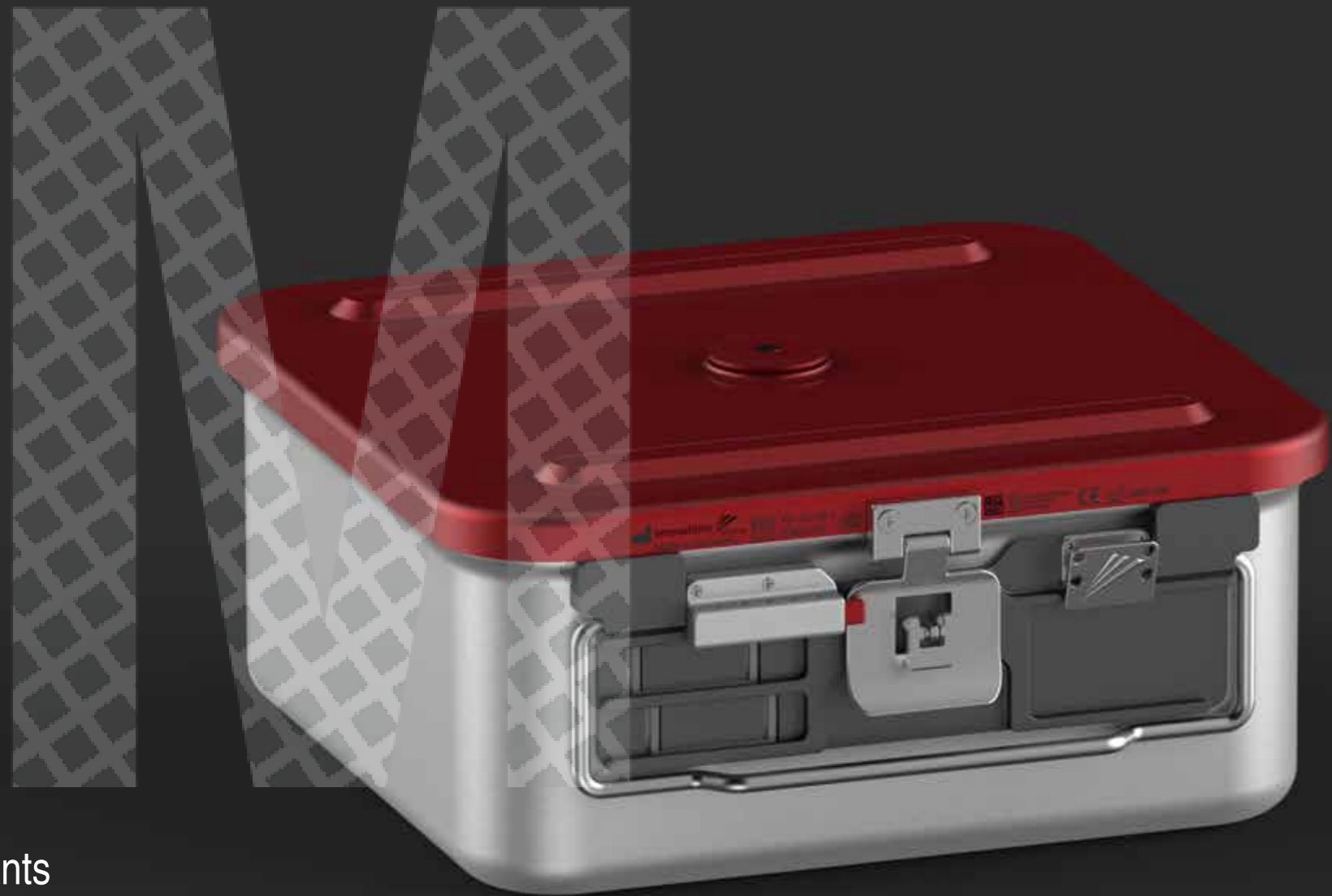

lid variants

EasyStop / paperfilter / permanentfilter / disposal container

container heights

100mm / 135mm / 150mm / 170mm / 220mm / 270mm



lid variants

EasyStop / disposal container

container heights

47mm / 62mm / 71mm

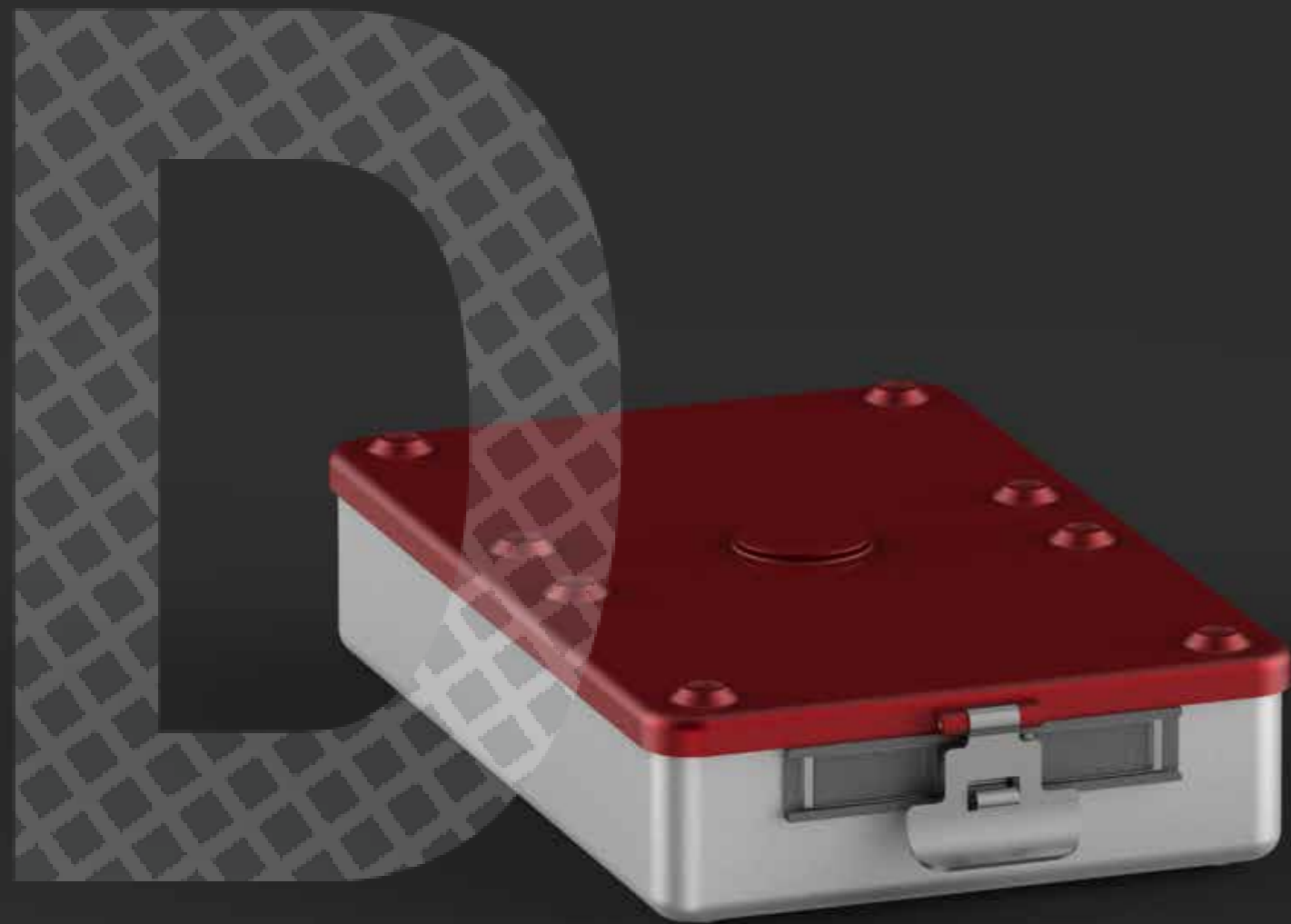

lid variants

EasyStop / disposal container

container heights

50mm / 67mm / 85mm

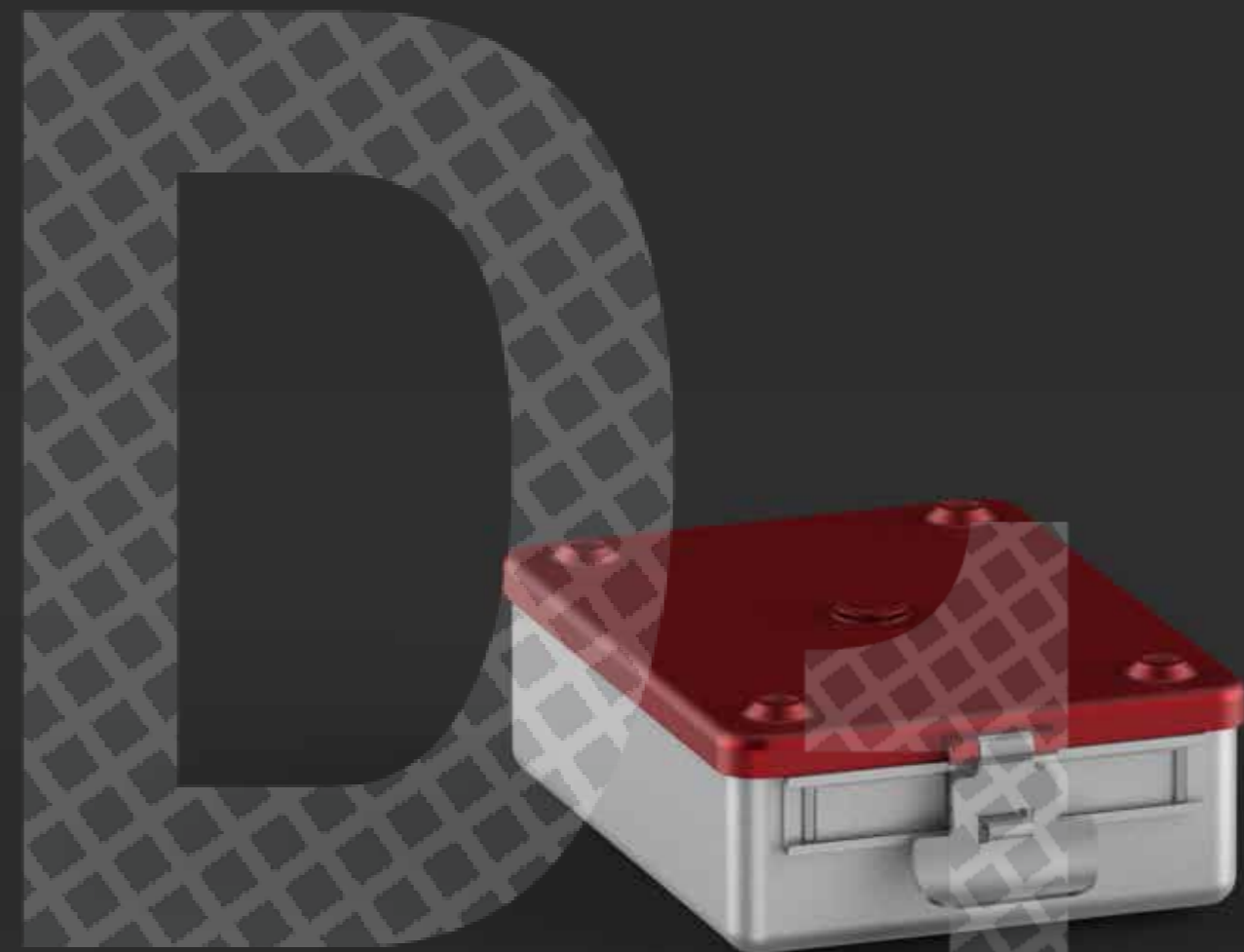

lid variants

EasyStop / disposal container

container heights

50mm / 67mm





Innovations Medical Badstraße 11, 78532 Tuttlingen

sustainable Innovations Medical

- Climate-neutral pellet heating system
- photovoltaic system



